

POWERSWITCH

Solid-State Relay / - Contactor With Analogue Input For Pulse Package Control PH 9260/042

Translation
of the original instructions

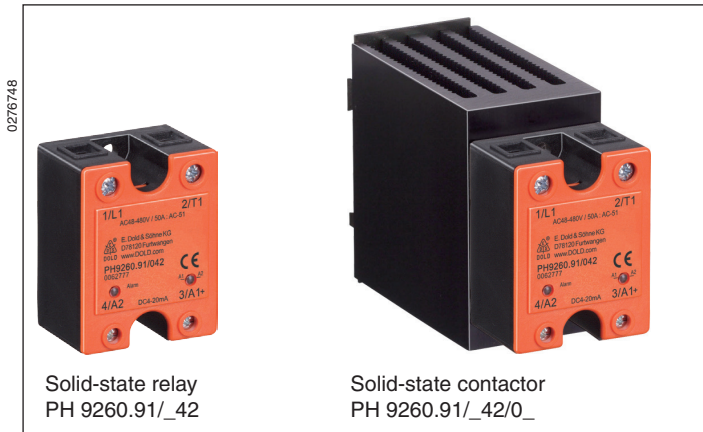

0276748

Solid-state relay
PH 9260.91/_42

Solid-state contactor
PH 9260.91/_42/0_

Your advantages

- Self-optimized impulse distribution with minimized cycle times
- Allows for precise temperature regulation
- Switching at zero crossing, providing outstanding EMC properties
- Protection from thermal overload with optional excess temperature protection

Features

- AC solid-state relay / -contactor for pulse package control of heating systems
- Control input DC 4 ... 20 mA
- According to IEC/EN 60947-4-2
- Nominal voltage AC 48 ... 480 V
- Load current 25A, 50 A, AC-51
- LED status indicator for control and failure
- Box terminals
- Degree of protection IP20
- As option with heat sink, for DIN rail mounting
- Width: 45 mm

Circuit Diagram

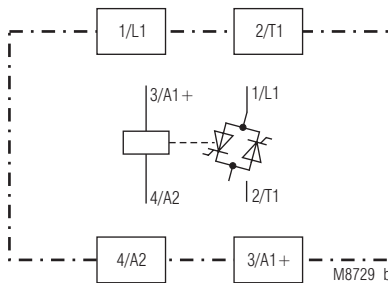

PH 9260.91/_42

Approvals and Markings



Applications

The zero crossing solid-state relay switches with 4 ... 20 mA analogue input for pulse package control is ideal for the control of heating elements and infrared lamps. It allows for precise temperature regulation, and offers a wide variety of potential applications with fast and noiseless switching, e.g. extrusion machines for plastic and rubber, at thermoforming machines, packaging machines or machines in food industry.

Connection terminals

Terminal designation	Signal designation
A1 (+), A2	Analogue control input
L1	Control input
A1	Load output

Functions

The solid-state relay PH 9260/042 is designed with 2 anti-parallel connected thyristors switching at zero crossing. The output of the solid-state relay is activated at the next zero crossing of the sinusoidal voltage. When disconnecting the control signal the output is switched off at the next zero crossing of the load current.

The on/off switching ratio of the output is set proportional to the control current. The control voltage range of 4 to 20 mA is converted into an on/off switching ratio of 0 to 100%. Two LEDs indicate the device status.

As option the solid-state relay is available with heatsink to be mounted on DIN rail. This provides optimum heat transmission.

Indication

Yellow LED „A1-A2“: Operating voltage and control current available. The flashing cycle corresponds to the on/off switching ratio specified by the control current. At a control current < 4 mA or > 25 mA, activation does not occur and the LED does not illuminate.

Red LED „Alarm“:
- Flashes slowly: At control current < 4 mA
- Flashes fast: At control current > 21 mA

Notes

Overtemperature protection

Optionally, the solid-state relay has an overtemperature protection to monitor the temperature of the heat sink. To this end, a thermal release switch (NC contact) can be inserted into the respective pocket at the bottom of the solid-state relay. As soon as the temperature of the heat sink exceeds for example 100°C, the thermal release switch. For thermal protection of the solid-state relay, a thermal release switch of UCHIYA type UP62 – 100 can be installed.

Technical Data

Control Input

Operation voltage A1/A2:	Max. 35 V DC
Burden voltage:	Max. 8 V (< 400 Ω at 20 mA)
Current range:	DC 4 ... 20 mA
Overcurrent protection:	Limit to 35 mA
Resolution:	5 %

Output

Load voltage AC [V]	48 ... 480	
Frequency range [Hz]:	47 ... 63	
Load current [A], AC-51:	25	50
Load limit integral I ² t [A ² s]:	800 6600 ¹⁾	1800 6600 ¹⁾
Max. overload current [A]	400	600
t = 10 ms:	1150 ¹⁾	1150 ¹⁾
Periodic overload current	40	120
t = 1 s [A]:	150 ¹⁾	150 ¹⁾
Min. current [mA]	20	
On-state voltage at nominal current [V]:	1.2	1.4
Peak reverse voltage [V]:	1200	
On-state voltage [V/μs]:	500	
Rate of rise of current [A/μs]:	100	
Temperature Data		
Thermal resistance junction - housing [K/W]:	0.6	0.5
Thermal resistance housing - ambient [K/W]:	12	
Junction temperature [°C]:	≤ 125	

¹⁾ Variant PH 9260.91/142

General Data

Operating mode:	Continuous operation	
Temperature range:		
Operation:	- 20 ... 40° C	
Storage:	- 20 ... 80° C	
Clearance and creepage distances		
Rated impulse voltage / pollution degree:	6 kV / 3	IEC/EN 60664-1
EMC:	IEC/EN 61 000-6-4,	IEC/EN 61000-4-1
Electrostatic discharge (ESD):	8 kV air / 4 kV contact	IEC/EN 61000-4-2
HF irradiation:	10 V / m	IEC/EN 61000-4-3
Fast transients:	2 kV	IEC/EN 61000-4-4
Surge voltages between		
Wires for power supply:	1 kV	IEC/EN 61000-4-5
Between wire and ground:	2 kV	IEC/EN 61000-4-5
HF-wire guided	10 V	IEC/EN 61000-4-6
Interference suppression:	Limit value class A*)	

*) The device is designed for the usage under industrial conditions (Class A, EN 55011)
When connected to a low voltage public system (Class B, EN 55011) radio interference can be generated. To avoid this, appropriate measures have to be taken.

Degree of protection

Housing:	IP 40	IEC/EN 60529
Terminals:	IP 20	IEC/EN 60529

Vibration resistance:

Amplitude 0.35 mm
frequency 10 ... 55 Hz, IEC/EN 60068-2-6

Housing material:

Fiberglass reinforced polycarbonate
Flame resistant: UL 94 V0

Base plate:

Aluminum, copper nickle-plated

Potting compound:

Polyurethane

Mounting screws:

M5 x 8 mm

Fixing torque:

2.5 Nm

Connections control circuit:

Mounting screws M3 Pozidrive 2 PT

Fixing torque:

0.5 Nm

Technical Data

Wire cross section:	1.5 mm ² wire
Connections load circuit:	Mounting screws M4 Pozidrive 1 PT
Fixing torque:	1.2 Nm
Wire cross section:	10 mm ² wire
Nominal insulation voltage	
Control circuit – load circuit:	4 kV _{eff.}
Load circuit – base plate:	4 kV _{eff.}
Overvoltage category:	II
Weight	
Without heat sink:	Approx. 100 g
PH 9260.91/_/_/_/01:	Approx. 530 g
PH 9260.91/_/_/_/02:	Approx. 650 g

Dimensions

Width x height x depth

Without heat sink:	45 x 59 x 32 mm
PH 9260.91/_/_/_/01:	45 x 80 x 124 mm
PH 9260.91/_/_/_/02:	45 x 100 x 124 mm

Dimensions

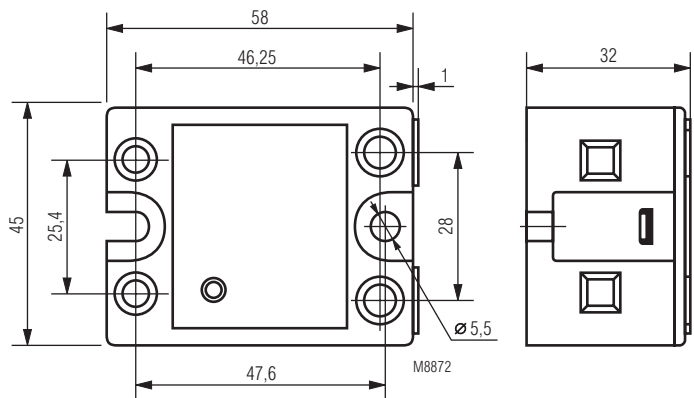

Accessories

PH 9260-0-12:	Graphite foil 55 x 40 x 0.25 mm to be fitted between device and heat sink, for better heat transmission Article number: 0058395
---------------	--

Characteristics

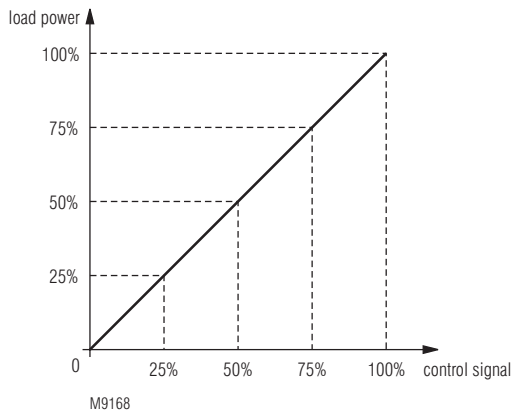

Control characteristic

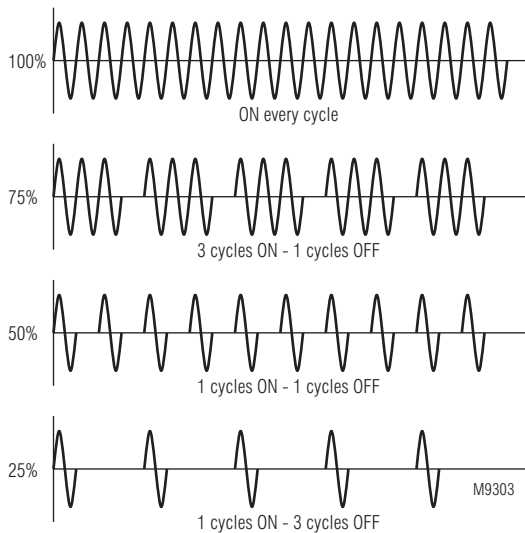

Cycle diagram with selfoptimizing puls packaging

Standard Type

PH 9260.91/042 AC 48 ... 480 V 50 A DC 4 ... 20 mA

Article number: 0062777

- Load voltage: AC 48 ... 480 V
- Load current: 50 A
- Control current: DC 4 ... 20 mA
- Width: 45 mm

Variants

PH 9260 .91 / _ 42 / 0 _

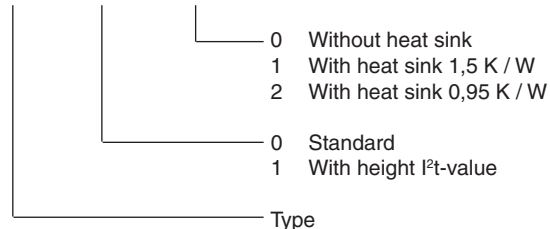

Ordering example for variants

PH 9260.91 /142 / 02 AC 48 ...480 V 50 A DC 4 ... 20 mA

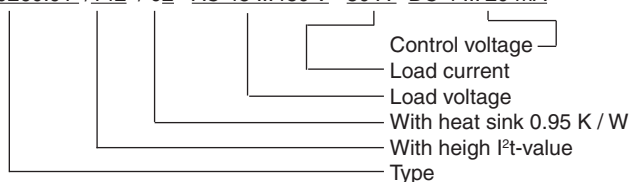

Notes on Sizing for Selection of a Heat Sink

The heat generated by the load current must be dissipated by a suitable heat sink. It is imperative that the junction temperature of the semiconductor is maintained for all potential environmental temperatures of under 125°C. For this reason, it is important to keep the thermal resistance between the base plate of the solid-state relay and the heat sink to a minimum.

To protect the solid-state relay effectively from excess heating, a thermally conducting paste should be applied before installation to the base plate of the heat sink between solid-state relay and heat sink.

From the tables below, select a suitable heat sink with the next lowest thermal resistance. Thus, it is ensured that the maximum junction temperature of 125°C is not exceeded. The load current in relation to the environmental temperature can be seen from the table.

Selection of a Heat Sink

Load current (A)	PH 9260 25 A					
	Thermal resistance (K/W)					
25.0	2.8	2.5	2.1	1.8	1.5	1.1
22.5	3.2	2.8	2.5	2.1	1.7	1.3
20.0	3.7	3.3	2.8	2.4	2.0	1.6
17.5	4.3	3.8	3.4	2.8	2.4	1.9
15.0	5.1	4.6	4.0	3.5	2.9	2.4
12.5	6.3	5.6	5.0	4.3	3.6	2.8
10.0	8.0	7.2	6.4	5.6	4.7	3.9
7.5	11.0	9.9	8.7	7.6	6.5	5.4
5.0	16.8	15.0	13.5	12.0	10.0	8.5
2.5	-	-	-	-	21.0	17.6
	20	30	40	50	60	70
	Ambient-temperature (°C)					

Load current (A)	PH 9260 50 A					
	Thermal resistance (K/W)					
50	0.9	0.7	0.6	0.4	0.3	-
45	1.0	0.9	0.7	0.5	0.4	0.2
40	1.2	1.0	0.9	0.7	0.5	0.3
35	1.5	1.3	1.0	0.9	0.7	0.5
30	1.9	1.6	1.4	1.1	0.9	0.7
25	2.4	2.0	1.8	1.5	1.2	0.9
20	3.0	2.7	2.4	2.0	1.9	1.3
15	4.4	3.9	3.4	2.9	2.5	2.0
10	6.9	6.0	5.4	4.7	4.0	3.3
5	14.0	12.9	11.5	10.0	8.6	7.2
	20	30	40	50	60	70
	Ambient-temperature (°C)					

Application Example

