

Insulated Enclosure KO 4737

with 4 high current terminal blocks for solder connection
and 4 twin-level terminal blocks for Plug-in technology

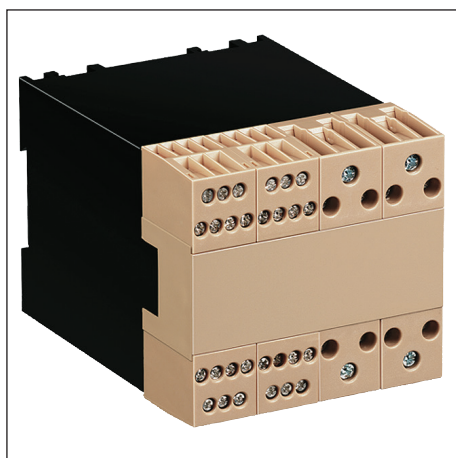

- Width 90 mm
- High current terminal block for soldering
 - Max. 12 box terminals with captive plus-minus terminal screw
 - Electrical connection of PCB to terminal via stranded ferruled
- twin-level terminal block for plug-in technology
 - Max. 28 box terminals with captive plus-minus terminal screw
 - Twin-level terminal
 - Removable terminal blocks for connection with PCB
 - Terminal blocks with choice of 3-; 4- or 7-terminals or as blanking block
- Installation of SMD components on outer surface (soldering side) possible
- Can be used for EExi complying with EN 50 020

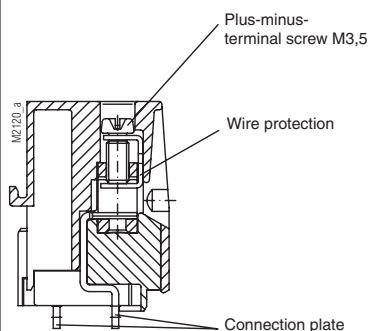

High current terminal block for soldering

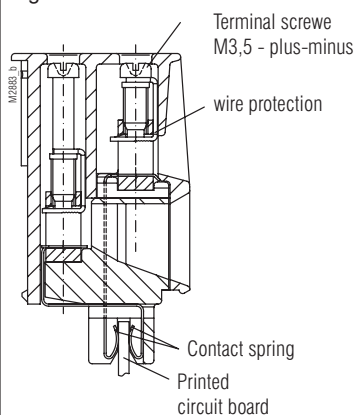

Twin-level box terminal for plug-in technology

Approval and Marking



Technische Daten

Order reference:	beige	grey RAL 7035	blue RAL 5015	clear	black
Base, with one clip PC	KO 4733-	1.6			1.1
Base, with one clip PA (UL)	KO 4733-				1.4
Base, with one clip PBT (UL)	KO 4733-				
Frame PC (UL)	KO 4737-	1-1.1	1-1.3	1-1.4	
Terminal block, 3 term. PC	KO 4733-	3.21	3.23	3.24	
Terminal block, 3 term. PA (UL)	KO 4733-				3.126
Terminal block, 3 term. PBT (UL)	KO 4733-		3.158		
Terminal block, 4 term. PC	KO 4733-	3.11	3.13	3.14	
Terminal block, 4 term. PA (UL)	KO 4733-				3.124
Terminal block, 4 term. PBT (UL)	KO 4733-		3.157		
Terminal block, 7 term. PC	KO 4733-	3.1	3.3	3.4	
Terminal block, 7 term. PA (UL)	KO 4733-				3.123
Terminal block, 7 term. PBT (UL)	KO 4733-		3.156		
Blanking block PC	KO 4733-	3.31	3.33	3.34	
High current terminal block, 3 terminals PC	KO 4734-	4.5			
High current terminal block, 3 terminals PA (UL)	KO 4734-				4.23
High current terminal block, 3 terminals PBT (UL)	KO 4734-		4.26		

Outer dimensions: 90 x 84 x 118 mm
Enclosure material: PC-GF, Base black, front beige









Temperature stability:	PC	PA	PBT
complying with UL 746 B:	125 °C	120 °C	120 °C
complying with Vicat ISO 306	Meth. A: 148 °C	Meth. A: 212 °C Meth. B: 212 °C	134 °C
compl. with ISO 75-2	Meth. A: 138 °C Meth. B: 144 °C	230 °C 210 °C	145 °C 150 °C

Max. permitted power dissipation:: 22 W for stand-alone enclosure at normal climate 23/50-1 ISO 554

Specific thermal resistance: R_{th} = 5.5 K / W for stand-alone enclosure

Flame retardancy:
complying with UL 94: PC: V-0; PC: plate clear = V-2; PA: V-0; PBT: V-0
complying with IEC 60 707: BH 2-30

	high current terminal block	twin-level terminal block
Number of terminals:	12, < 12 on request	28, < 28 on request
Terminal material:	steel strip, tin-plated	Cu-alloy tin-plated
Max. cross section for connection:	1 x 10 mm ² solid insulation 11 mm	1 x 2.5 mm ² stranded ferruled DIN 46 228-1/-2/-3/-4
	1 x 6 mm ² -12 stranded ferruled DIN 46 228-1/-2/-3/-4	1 x 4 mm ² solid 2 x 1.5 mm ² stranded ferruled DIN 46 228-1/-2/-3/-4
Min. cross section for connection:	≥ 1 mm ² solid ≥ 0.5 mm ² strand.ferruled	
Insulation of wires length:	11 mm	10 mm
Max. current carrying capacity:	40 A	see table

Max. current carrying capacity twin-level box terminal	Ex. 1	Ex. 2	Ex. 3	Ex. 4	Ex. 5
 Σ I _{max.} = 15 A	 5 5				
 Σ I _{max.} = 28 A	7 7 7 7	 6 7 7	8 6 8 6		
 Σ I _{max.} = 35 A	 5 5 5	 5 5 5	3 2 2	2 3 2	1 1 5
	5 5 5 5	8 4 4 4	 6 7 7	 7 7 7 7	8 6 8 6

 = max. value per terminal point,  = max. value per terminal row

Technical Data

Wire fastening:	captive plus-minus-terminal screws M4	captive plus-minus-terminal screws M3,5
	Box terminal with self raising wire protection	
Torque:	1.2 Nm	0.8 Nm
Inner connection:	solder connection	direct connection of PCB
Enclosure fastener:	1) Snap-on fastener on top hat rail EN 50 022 2) Screw fixing M4, grid 90 mm with additional clip as accessories	
Creepage current resistance:	PC: CTI 175 $\hat{=}$ insulating material III a IEC 60 664-1 PA: CTI 600 $\hat{=}$ insulating material I IEC 60 664-1 PBT: CTI 225 $\hat{=}$ insulating material III IEC 60 664-1	
Air gap and creepage distance:	≥ 5.5 mm complying with IEC 60 664-1	≥ 3.3 mm complying with IEC 60 664-1 with plugged-in PCB
Type of protection	IP 40 IEC 60 529	
Enclosure:	with terminal screws: IP 20 IEC 60 529	
Terminals:	contact protection complies with VBG 4	
Printed area:	90 x 33 mm	
Printed circuit board:	see printed circuit design	
Printed circuit board holder:	guide ribs	
Net weight:	320 g	

Accessories:		grey RAL 7035	blue RAL 5015	black
Legend plate for twin-level terminal block	KO 4730-	3-1.3	3-1.4	3-1.5
2 clips for screw fastener	ET 4086-0-2			

Exploded view

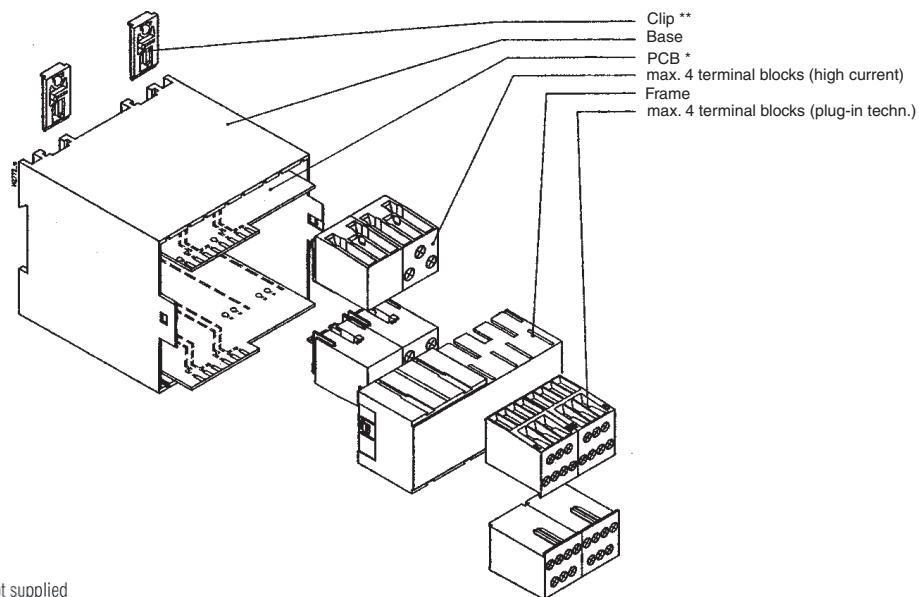

* not supplied
** see accessories

Dimensions

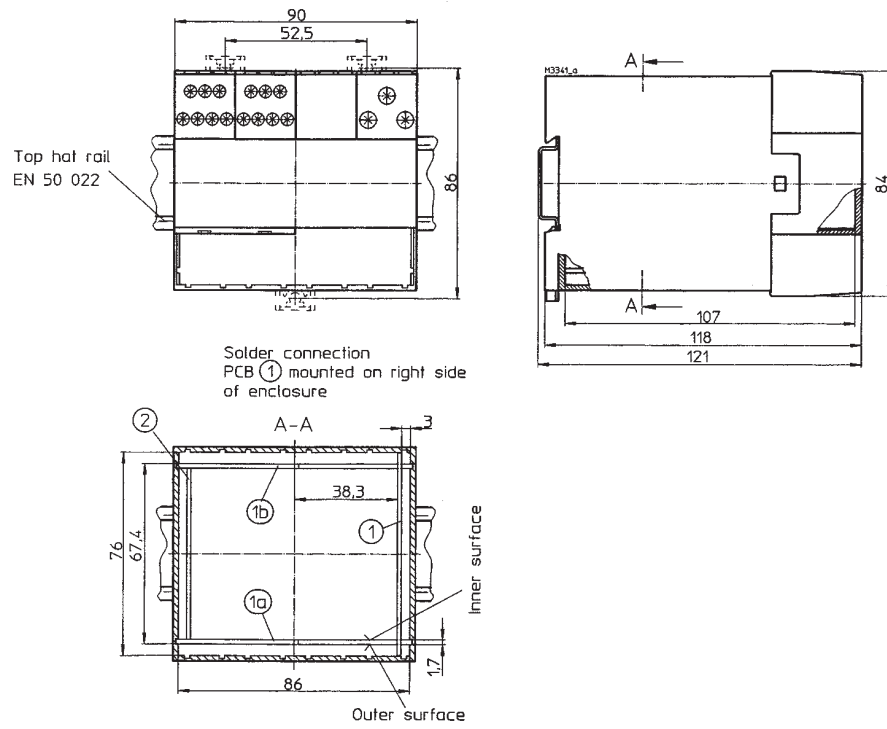

Printed circuit board designs

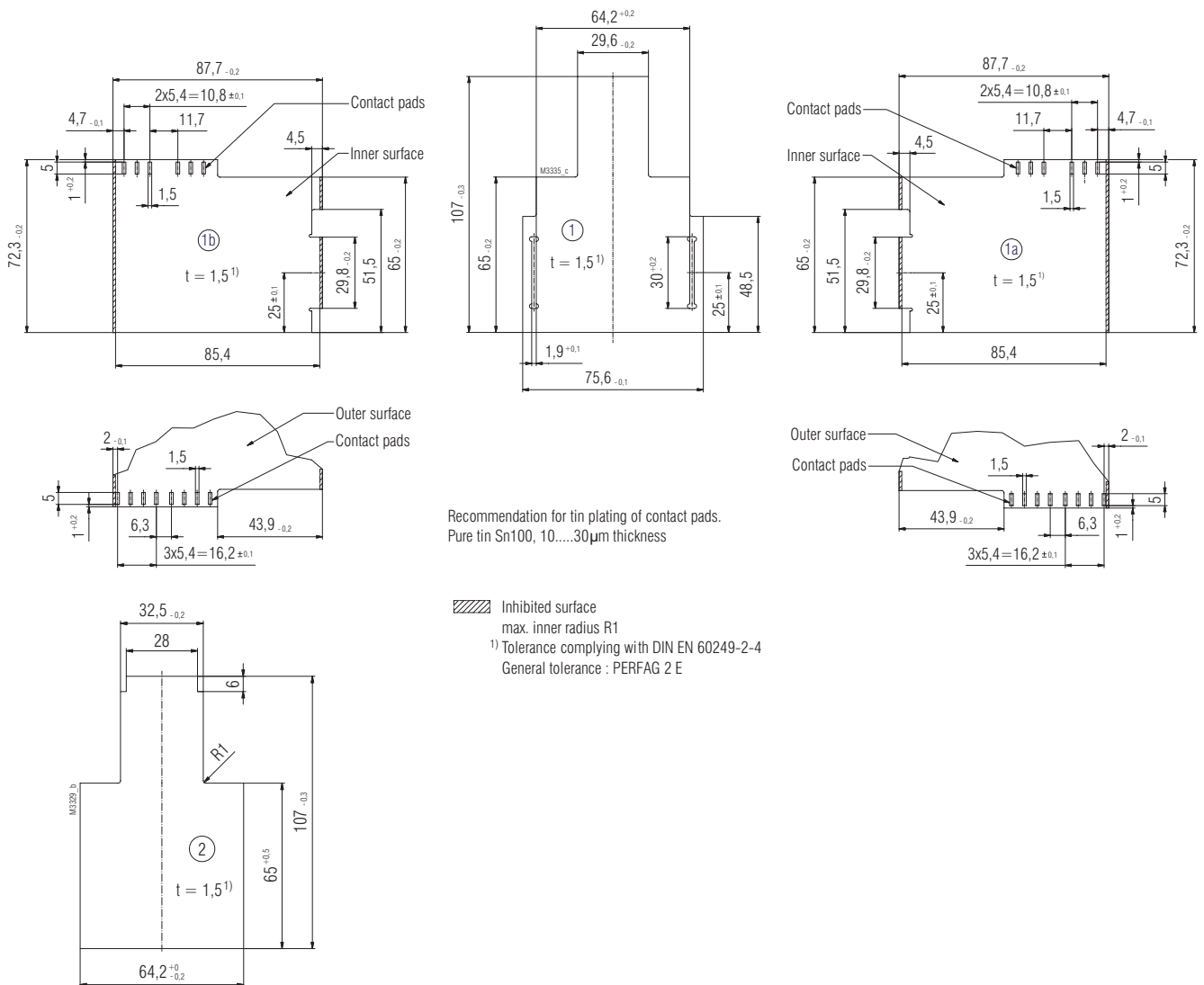

Notes on Housing Opening

1. Tool

- for all functions use 0.8 x 4,0 or 0.8 x 4.5 screwdriver

2. Removing of terminal blocks and frame

- Insert a screwdriver in the side recesses of the base (underneath)
- With light pressure, turn the screwdriver to the left or right.
- The snap-in lug of the frame disengages.
- Repeat disengaging process on opposite side.
- Terminal blocks with frame can be removed.

